



2nd NATURAL SCIENCE OLYMPIAD

2nd MAY 2012

GRADE 4 - 6

09:00 – 11:00

INSTRUCTIONS

Read the instructions carefully before answering the questions

This is a multiple choice paper. Answer all the questions on the answer sheet provided. Each question is followed by answers marked A, B, C, D. Only one of these is correct. Choose the most correct answer and colour in the corresponding circle completely with an HB pencil.

NB! Do not make other dots or marks, and do not mark more than one answer. The answer sheets are marked by computer and it is important that you mark the spaces dark enough, otherwise they will be missed.

Ensure that your responses are marked opposite the correct number for each question. If you want to alter an answer, erase the wrong answer completely, otherwise you may score zero for a correct answer.

Note that the question numbers on the answer sheet run from top to bottom. Also note that the paper consists of **questions 1 – 70**.

Non-programmable electronic calculators may be used.

You must also fill in all the required information on the answer sheet. Note that your student number was sent to your school and your teacher or invigilator will supply it. It is a number with eight digits e.g. 08149701.

Enter the digits in the correct sequence from left to right in the empty blocks, and also blacken the corresponding circles underneath the blocks with a pencil.

**Two hours are allowed to answer the questions
Do not fold the answer sheets.**

1. What is shown in the diagram below?

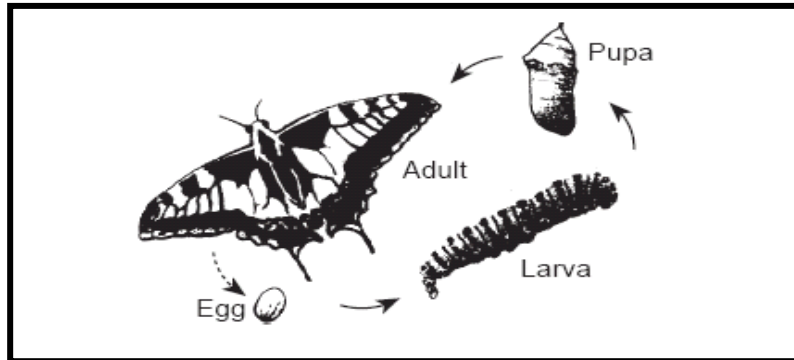

- A. A life span
- B. A population
- C. A life cycle
- D. A community

2. Answer the question based on the graph below, which shows the average number of calories needed each day by young people.

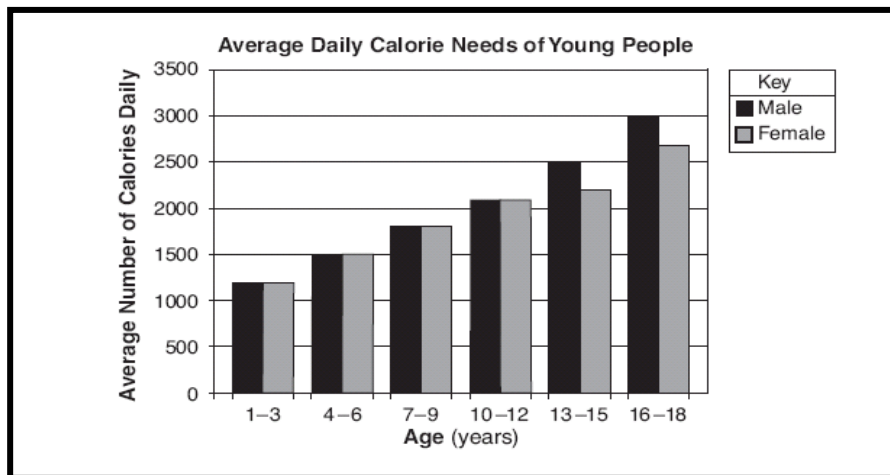

How many more average daily Calories are needed by a 17-year-old male than by a 17-year-old female?

- A. 300
- B. 500
- C. 2700
- D. 3000

3. The diagram below shows Earth at four locations in its orbit around the Sun.

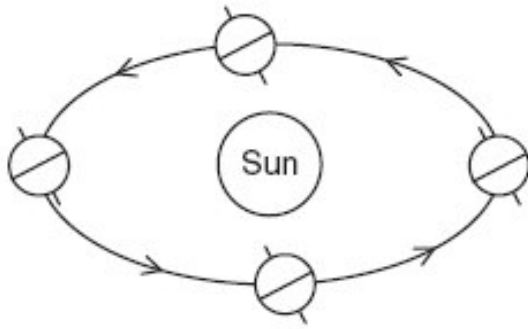

Which motion do the arrows in the diagram represent?

- A. Earth's rotation
- B. the Sun's rotation
- C. Earth's revolution
- D. the Sun's revolution

Base your answers to Questions 4 and 5 on the diagram below and on your knowledge of science. The diagram represents the motion of the Moon around Earth as seen from above the North Pole. One position of the Moon in its orbit is shown.

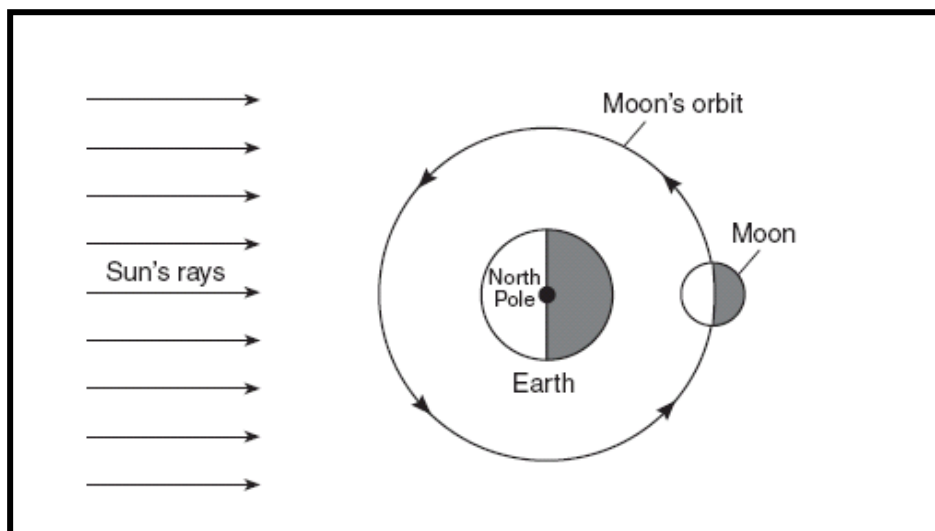

4. Which Moon phase will usually be seen from Earth when the Moon is in this position?

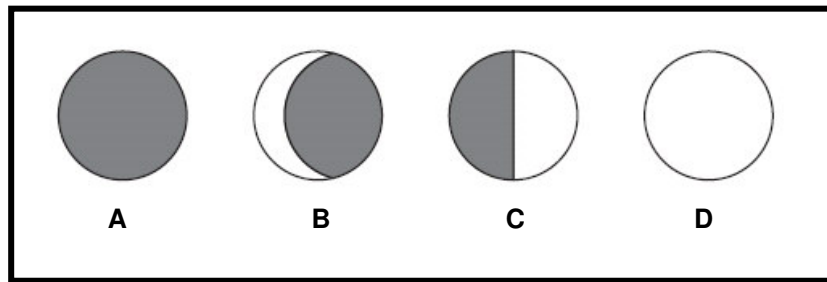

5. The time it takes the Moon to revolve once around the Earth is approximately one...

- A. day
- B. week
- C. month
- D. year

6. The cartoon below shows a humorous view of a scientific phenomenon. What process is occurring that makes the child's breath become visible?



- A. boiling
- B. melting
- C. condensation
- D. evaporation

7. The bar graph below shows the average life span of five different animals.

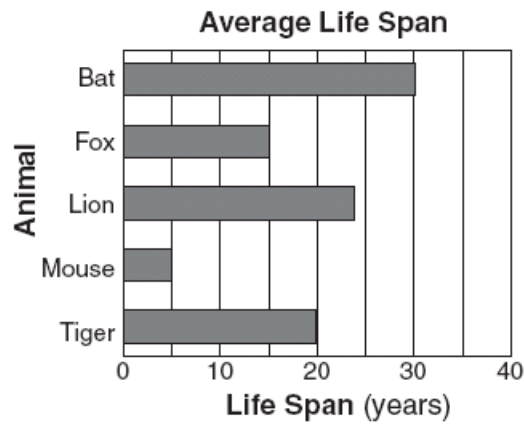

How much longer is the life span of a bat than the life span of a fox?

- A. 5 years
- B. 10 years
- C. 15 years
- D. 20 years

8. The diagram below shows the effect of a river on an area over many years.

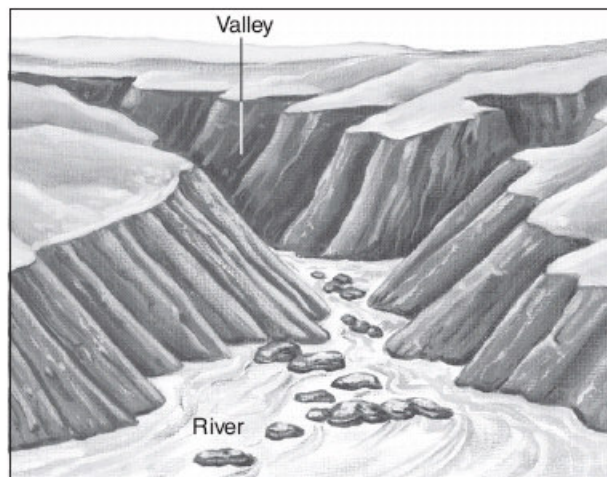

Which process caused the valley to form?

- A. erosion
- B. deposition
- C. condensation
- D. evaporation

9. The diagram below shows a fox and an owl both trying to catch a rabbit.

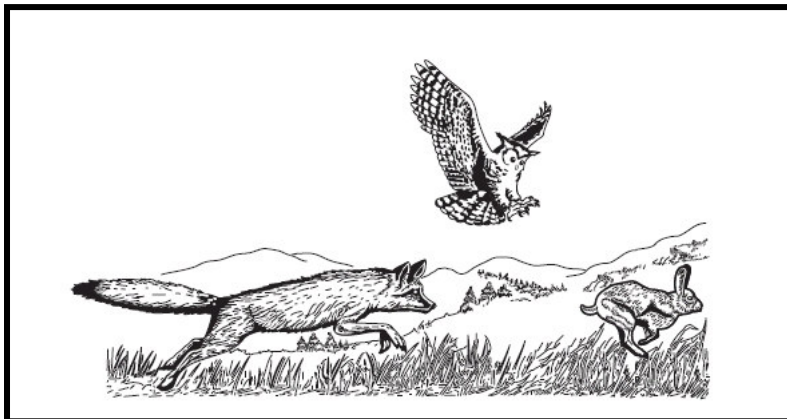

The fox and the owl are both ...

- A. finding a mate.
 - B. competing for food.
 - C. seeking shelter.
 - D. migrating for winter.
10. The diagram below shows an area before and after a housing development was built there.

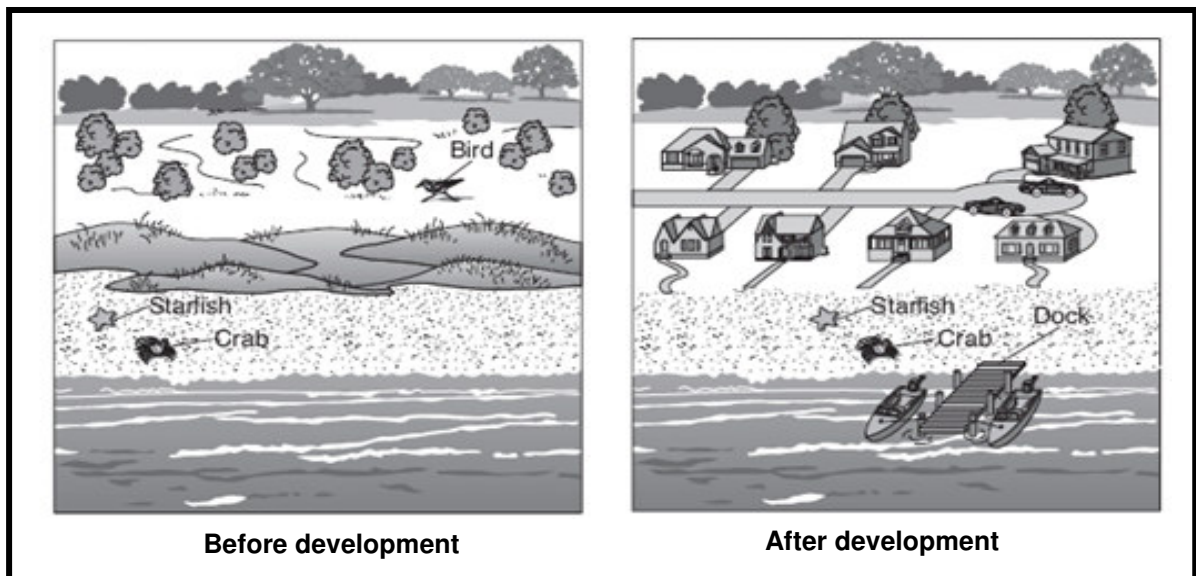

Select ONE statement from the alternatives (A, B, C or D) given below which shows a negative way that animals living in the area have been affected by the changes shown in the diagrams above.

- A. There are more trees for the animals
- B. The bird's habitat has been disturbed
- C. The removal of the dunes allow more space for the crabs and starfish
- D. There is more vegetation for the animals

11. The diagram shows four identical marbles and a graduated cylinder containing 43mL of water.

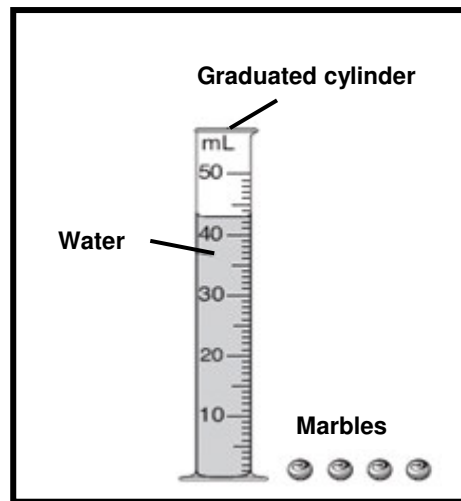

A learner puts two marbles in the cylinder and the water level rises from 43mL to 45mL. The learner then puts the other two marbles in the graduated cylinder. What will the water level be when all four marbles are in the graduated cylinder?

- A. 43mL
- B. 45mL
- C. 47mL
- D. 49mL

12. The graph below shows the number of each kind of item Marcia recycled last week.

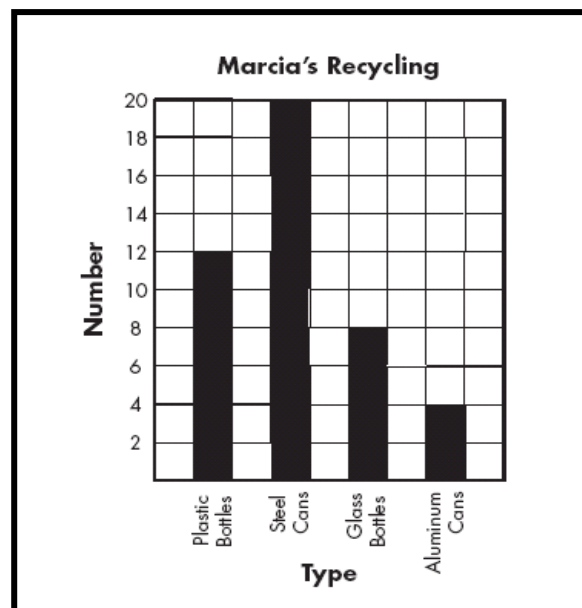

How many more plastic bottles than glass bottles did Marcia recycle?

- A. 2
 - B. 4
 - C. 8
 - D. 12
13. Which one of the following is a characteristic of parasitism?
- A. One organism kills and consumes another.
 - B. Two organisms live together and neither is harmed.
 - C. One organism lives in or on another and benefits.
 - D. Two organisms nourish each other; both benefit.

14. Study the pea plant below and answer the Question that follows.

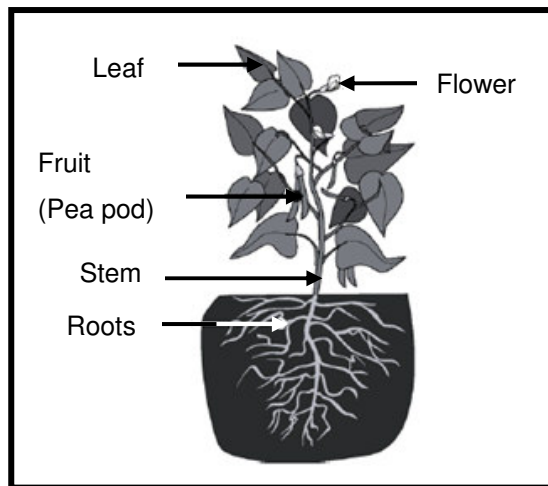

A plant's stem is used to ...

- A. supports the plant.
 - B. produces seeds for the plant.
 - C. anchors the plant in the soil.
 - D. absorbs water and minerals from the soil.
15. Which item would decompose the quickest in this learner's lunch bag?

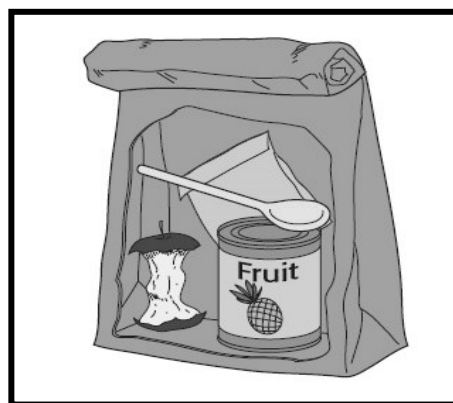

- A. Fruit can
- B. Apple core
- C. Plastic bag
- D. Wooden spoon

16. Each year Earth moves once around ...
- A. Mars
 - B. Venus
 - C. the Sun
 - D. the Moon
17. A girl found the skull of an animal. She did not know what the animal was, but she was sure that it preyed on other animals for its food. Which clue led to her conclusion?
- A. The eye sockets faced sideways.
 - B. The skull was much longer than it was wide.
 - C. There was a projecting ridge on the front of the skull.
 - D. Four of the teeth were long and pointed.
18. Paul built a model of the Sun, the Moon, and Earth shown below. This model was not built to scale

Which phase of the Moon is shown in Paul's model?

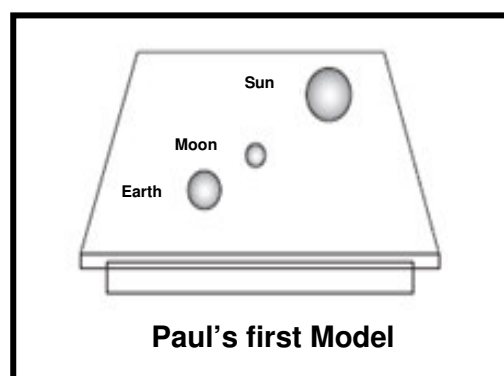

- A. Full moon
- B. New moon
- C. First quarter
- D. Third quarter

19. The amount of direct sunlight the Northern Hemisphere receives changes throughout the year. The diagram below shows Earth revolving around the Sun.

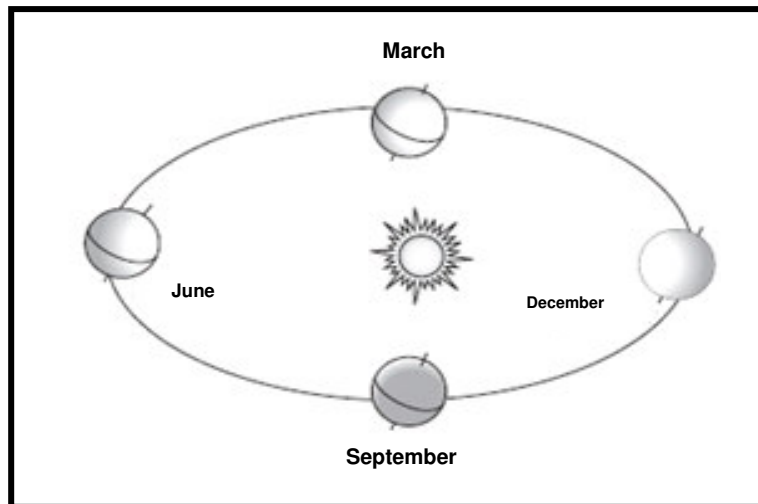

In which month will the Northern Hemisphere receive the greatest amount of direct sunlight?

- A. March
 - B. June
 - C. September
 - D. December
20. Carl read a science fiction story in which a woman travelled to a planet in another galaxy. He knows that to travel to other galaxies is not yet possible. Which of the following is the main reason why humans are not able to travel to other galaxies?
- A. Planets in other galaxies are too far away.
 - B. Planets in other galaxies do not have gravity.
 - C. Planets in other galaxies are too cold for humans.
 - D. Planets in other galaxies have no solid landing surfaces.

21. The diagram below shows a simple food web.

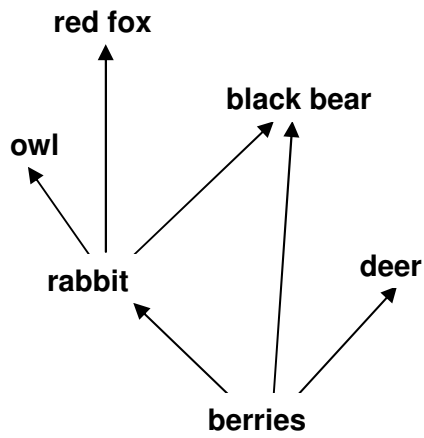

Which animal is classified as an omnivore?

- A. red fox
- B. deer
- C. black bear
- D. rabbit

22. The graph below shows the average rainfall in an area. Study the graph and answer the question that follows.

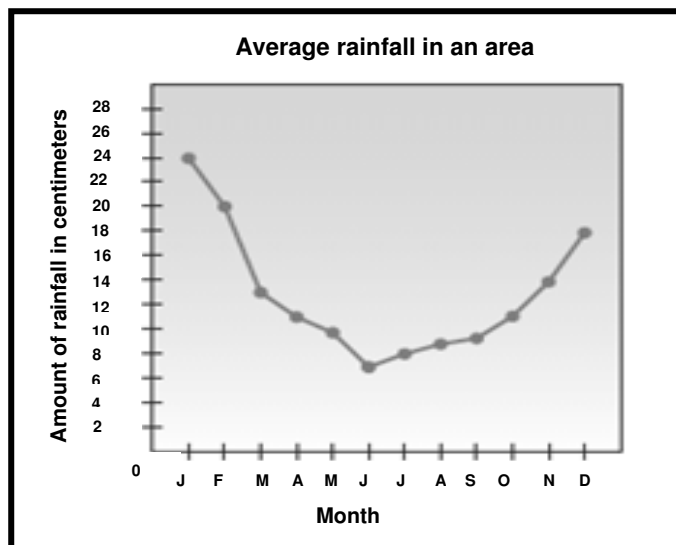

How much more rain fell in February than in November?

- A. 4 centimeters
- B. 6 centimeters
- C. 14 centimeters
- D. 16 centimeters

23. The picture below shows the earth spinning on its axis. What would happen if the earth spun faster?

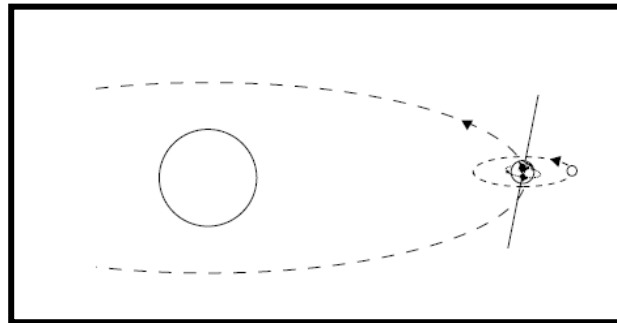

- A. Days would be hotter.
 - B. Days would be less than 24 hours long.
 - C. Days would be colder.
 - D. Days would be longer than 24 hours long.
24. A coal-burning facility is constructed in an area containing several pond ecosystems. How will this human activity most likely affect the pond ecosystems?
- A. More nutrients will be available.
 - B. Organism diversity will increase.
 - C. Disease will become less common.
 - D. Water quality will be reduced.

25. Which diagram below represents the human digestive system?

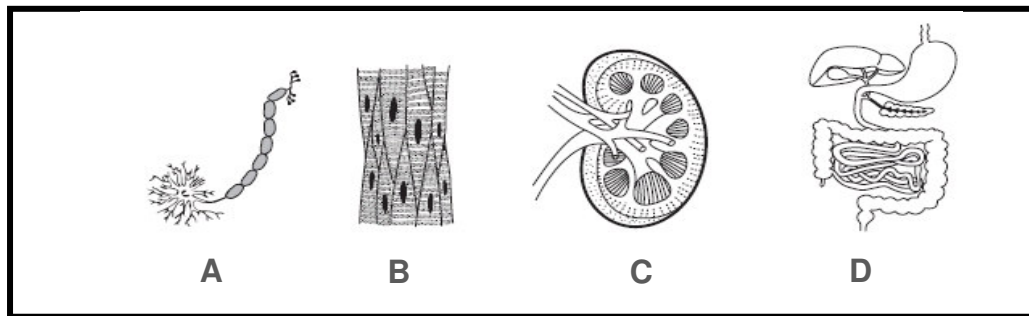

26. The digestive system processes food into usable and unusable materials. The usable materials are sent to the body's cells as food. What happens to unusable materials?

- A. It goes into the pancreas to await disposal.
- B. It goes to the right ventricle to await disposal.
- C. It goes into the large intestine to await disposal.
- D. It goes into the small intestine to await disposal.

27. How many bones are there in the average person's body?

- A. 33
- B. 206
- C. 639
- D. It varies by the individual.

28. You can become infected with HIV by...

- A. sharing utensils with or drinking from the same cup as someone with HIV.
- B. mosquito bites.
- C. hugging someone with HIV.
- D. none of the above.

29. Study the diagram below which illustrate combustion of fossil fuels and answer the Question that follows.



Give the name of the harmless colourless liquid at room temperature, formed by the combustion of a fossil fuel.

- A. carbon dioxide
 - B. carbon monoxide
 - C. nitrogen dioxide
 - D. water
30. The diagram below represents the Earth rotating as viewed directly above the South Pole.
Which point will most likely correspond to 12 noon?

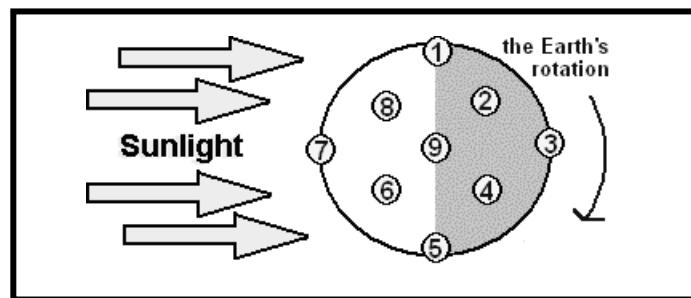

- A. Point 8
- B. Point 7
- C. Point 4
- D. Point 3

31. A healthy diet needs a balance of many things. Fruit, vegetables and table salt are ALL good sources of ...

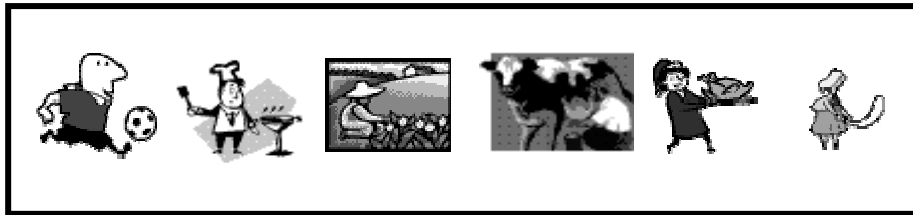

- A. water.
- B. protein.
- C. carbohydrates.
- D. minerals.

32. Sugar is composed of carbon, hydrogen and oxygen. Sugar is an example of which one of the following:

- A. an atom
- B. a compound
- C. an element
- D. a mixture

33. Which graph best shows the amount of pollutants in the air and the quality of the air?

- A.
- B.
- C.
- D.

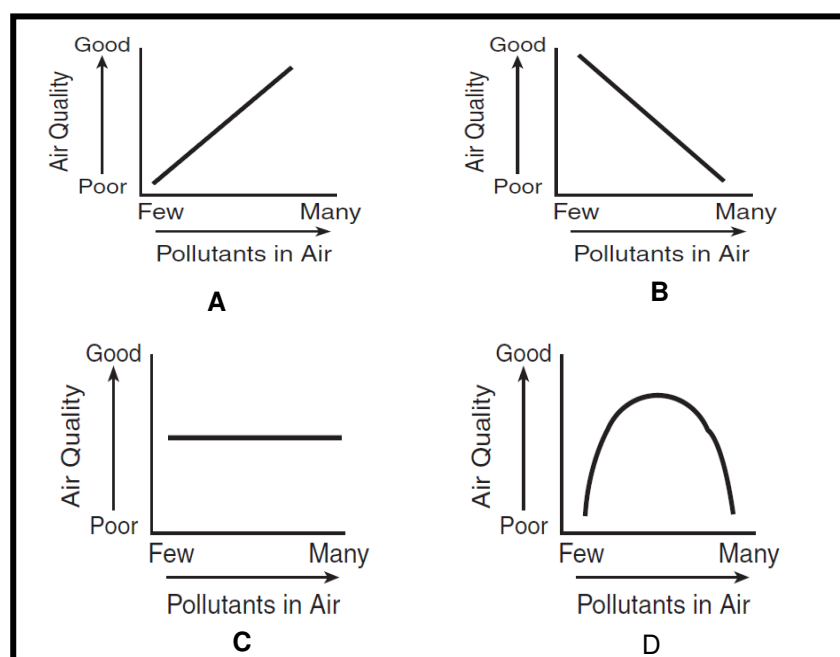

34. Which energy change is best shown in the diagram below?

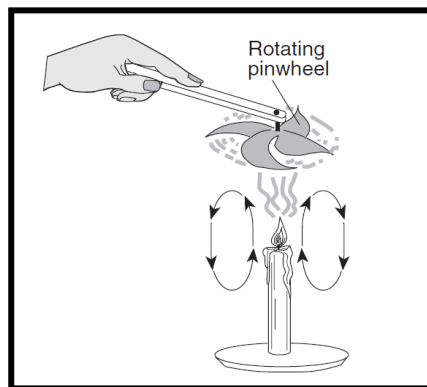

- A. Heat to mechanical.
- B. Sound to heat.
- C. Heat to sound.
- D. Mechanical to light.

35. Mary, Zandile and Sipho carried out an investigation to determine the causes of rusting. The amount of rust was measured. Study the diagram below and answer the Question that follows.

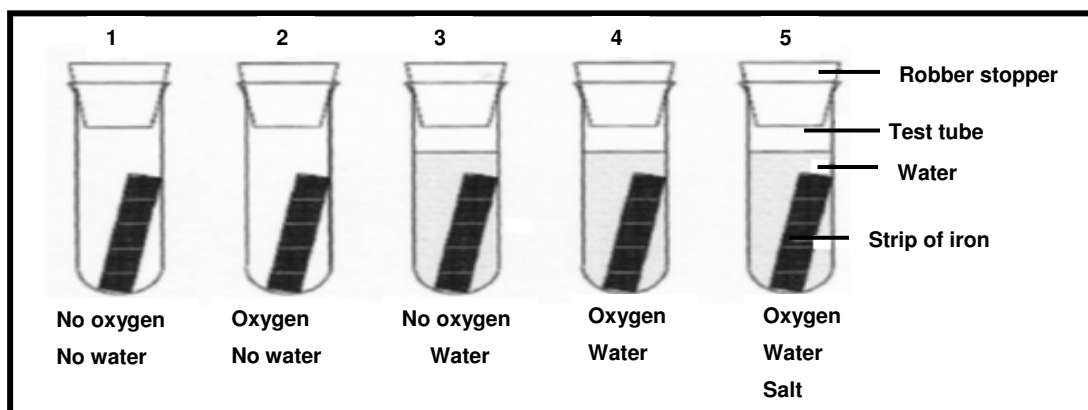

Which two of the test tubes will show the most rust?

- A. 1 and 3
- B. 2 and 3
- C. 3 and 4
- D. 4 and 5

36. Energy from the sun reaches Earth mainly by the process of ...

- A. conduction.
- B. reflection.
- C. convection.
- D. radiation.

37. Which energy source is nonrenewable energy?

- A. solar
- B. moving water
- C. wind
- D. fossil fuel

38. The diagram below uses the letters A, B, C and D to represent processes occurring in the water cycle.

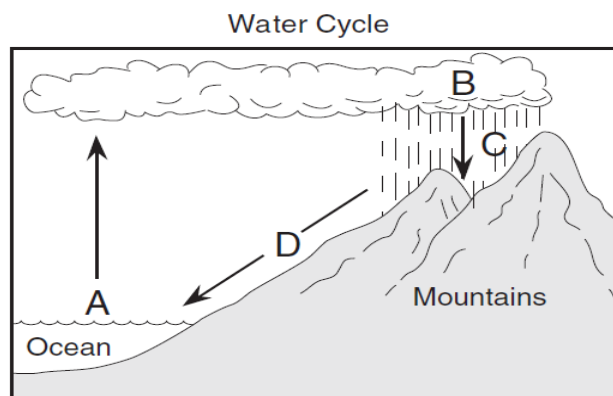

Letter	Process that is occurring
A	precipitation
B	condensation
C	rain
D	run off

Which process is *not correctly* labeled?

- A.
- B.
- C.
- D.

39. When will the most evaporation take place?

- A. On a cool, windy day.
- B. On a hot, still day.
- C. On a hot, windy day.
- D. On a cool, still day.

40. The picture below shows Nomusa's fish tank.

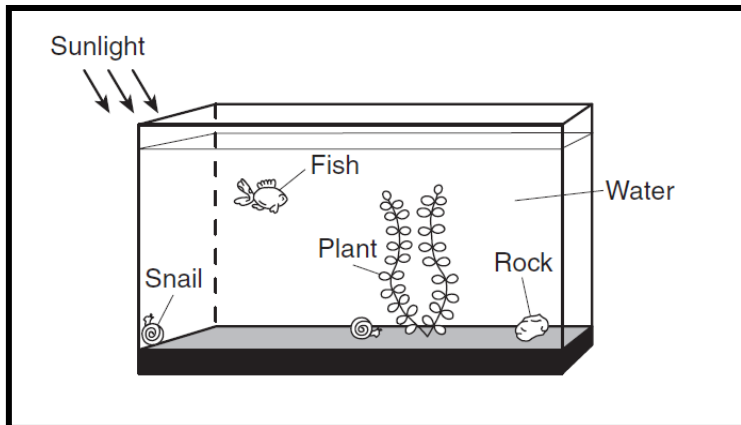

Which item in the tank produces oxygen?

- A. plant
- B. snail
- C. water
- D. rock

41. An increase in the amount of greenhouse gases entering the Earth's atmosphere causes ...
- A. a decrease in sea level.
 - B. a decrease in temperatures.
 - C. an increasing in melting of the polar caps.
 - D. increase in Earths movement.
42. Somaya is trying to dissolve two tablespoons of salt in a glass of water. What can she do to make the salt dissolve faster?
- A. use colder water
 - B. use larger pieces of salt
 - C. stir rapidly
 - D. use less water
43. In the above experiment which is true?
- A. the salt which dissolves in the water is called the solvent.
 - B. the salt which dissolves in the water is called the solution.
 - C. the water is called the solute.
 - D. the water with dissolved salt is known as the solution.

44. Study the cartoon below and answer the Question that follows.



The process pictured in the cartoon is best described as...

- A. evaporation
- B. condensation
- C. expansion
- D. contraction

45. Read this letter and study the table below to answer the Question that follows.

Dear Vusi

I have been thinking of you, enjoying sunny South Africa. It is very different here in England where it is winter now. The days are so short and it is very cold. I am wearing the warm hat that Gogo knitted. It was very exciting to see snow for the first time.

Lots of love

Your sister

Thandi

	Minimum temperature in °C	Maximum temperature in °C
A	21	28
B	0	8
C	15	21
D	11	27

What is the temperature likely to be in England?

- A.
- B.
- C.
- D.

46. Anita is pumping up the tyres of her bicycle. The tyres become firm because....

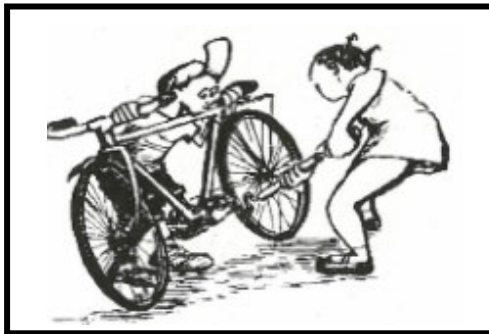

- A. there is good ventilation.
 - B. air can be compressed.
 - C. there is warm air in the tires.
 - D. there is clean air in the tires.
47. At our Human Right's Day function, Silas was playing the drums. Which kind of energy was produced when he beat the drums?
- A. electrical
 - B. sound
 - C. light
 - D. chemical

48. The picture below shows water boiling in a metal pan on a hot stove burner. Why is the handle made of wood?

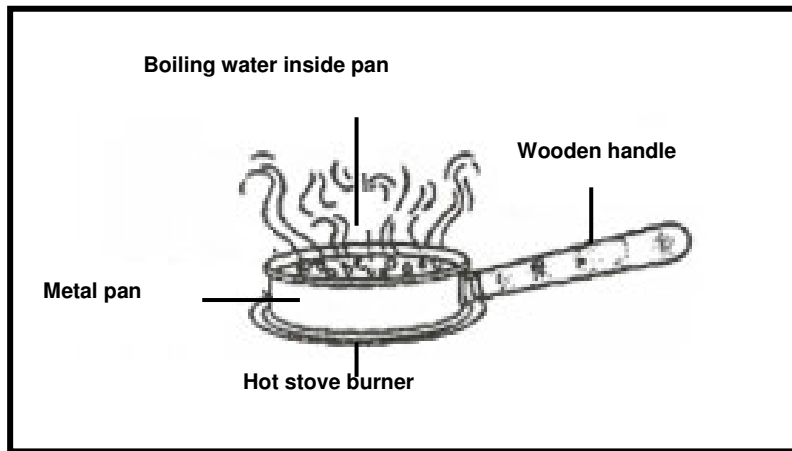

- A. wood conducts electricity
B. wood does not conduct electricity
C. wood is cheaper
D. the pan would not be too heavy
49. A tight metal lid on a jar of pickles may loosen when it has been held in hot water. This is because the hot water causes the...
- A. glass jar to contract.
B. metal lid to contract.
C. glass jar to expand more than the metal lid expands.
D. metal lid to expand more than the glass jar expands.

50. Naz and Semiha were studying friction and decided to do an experiment. They placed four equally sized blocks made of different materials on an elevated plastic tray. They watched the blocks move down the tray. Which block would experience the least amount of friction as it moved down the tray?

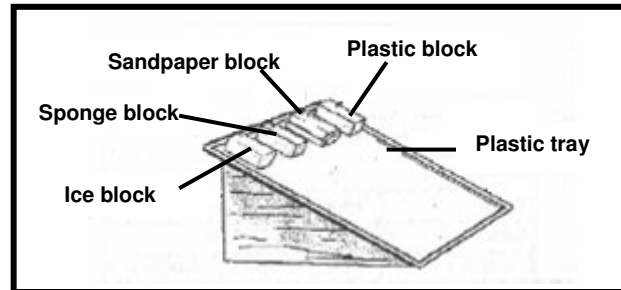

- A. Ice block
B. Sponge block
C. Sandpaper block
D. Plastic block
51. A battery consists of two or more cells that can supply electrical energy. The cell contains _____ that can be converted to electrical energy.
- A. potential energy
B. chemical energy
C. kinetic energy
D. solar energy
52. During the process of photosynthesis, plants use the light of the sun, their chlorophyll and the _____ in the air to make food in their leaves.

What is this gas called?

- A. oxygen
B. hydrogen
C. carbon dioxide
D. water vapour

53. Joyce put 100ml of water in each of these open containers and let them stand for a day.

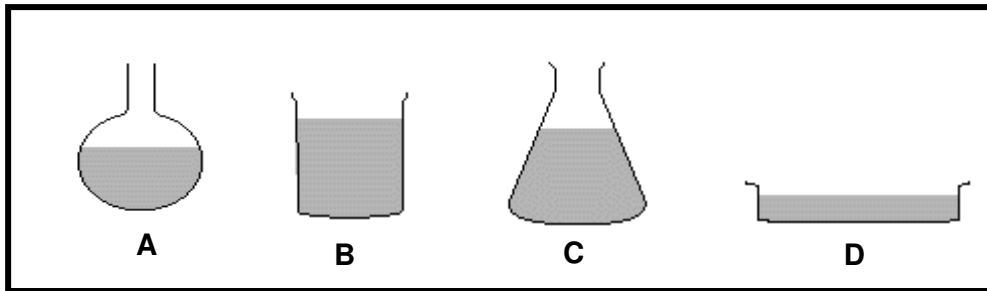

Which container probably lost most water due to evaporation A, B, C or D?

54. The diagram below shows four different Celsius Thermometers. The body temperature of sick people ranges from 36 degrees Celsius to 42 degrees Celsius.

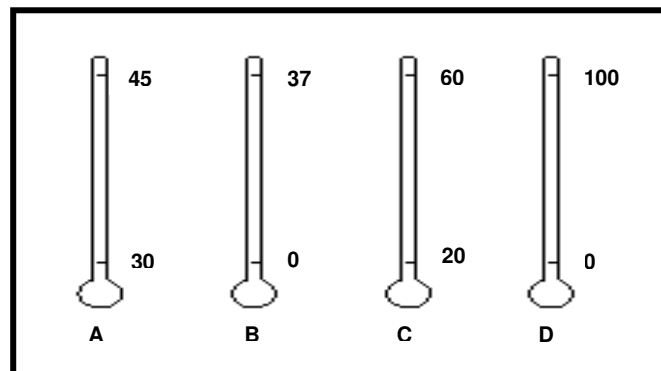

Which thermometer would be most suited for accurately measuring body temperature?

- A.
- B.
- C.
- D.

55. The filter funnel shown below can be used for separating which of the following substances?

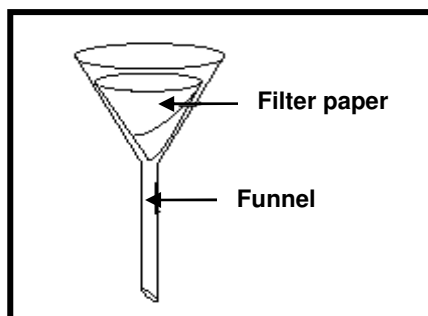

- A. a solution of salt and water
B. a mixture of paraffin and water
C. a mixture of mud and water
D. a mixture of sand and sawdust
56. Air is made up of many gases. Which gas is found in the greatest amount in the atmosphere?
- A. oxygen
B. nitrogen
C. hydrogen
D. water vapour
57. Which gas could cause a glowing splint to burst into flame?
- A. carbon dioxide
B. hydrogen
C. oxygen
D. nitrogen

58. When light hits a smooth, shiny surface like a mirror, it is...

- A. refracted
- B. absorbed
- C. transmitted
- D. Reflected

59. Which is an example of a physical change?

- A. ice melting
- B. iron rusting
- C. a candle burning
- D. yeast used to make bread

60. When water falls to the Earth, we call it precipitation. It can fall in different forms. Use this word block to find examples of the forms of precipitation. Read up, down, forwards and backwards to identify all the forms of precipitation.

H	M	R	A	I	N	W
A	B	E	W	O	N	S
I	W	E	D	H	N	G
L	X	F	R	O	S	T

The total number of examples given of the forms of precipitation in the block is

- A. 2
- B. 3
- C. 4
- D. 5

61. The graph shows the sources of energy used by 4 different countries.

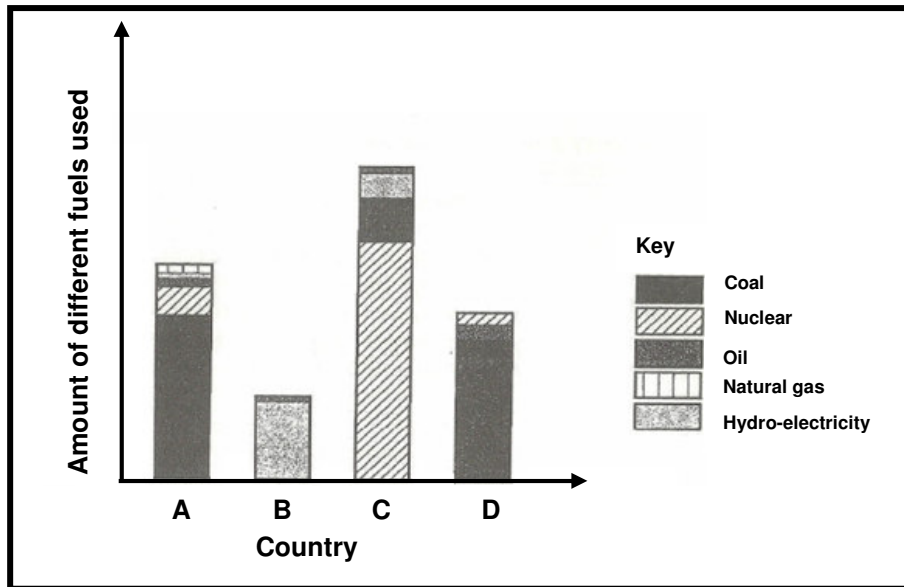

Which country uses the largest amount of nuclear energy?

- A.
- B.
- C.
- D.

62. The following is a list of pieces which form part of the laboratory equipment:

Battery, goggles, spring scale, magnifying lens

Which piece of laboratory equipment is used for safety?

- A. goggles
- B. magnifying lens
- C. battery
- D. spring scale

63. Tommy was walking through garden and saw an apple fall from a tree. What force caused the apple to fall to the ground?

- A. friction
- B. collision
- C. magnetism
- D. gravity

64. The table below shows the percentage of water used by a household.

Activities	Percentage of water used
Taking baths	9
Cooking	8
Toilet flushing	16
Washing clothes	20
Showering	17
Gardening	27
Other	3

What is the difference in percentage between the water used for flushing toilets and gardening?

- A. 21
- B. 43
- C. 11
- D. 9

65. One morning, Thabi went for a walk in the garden. She saw droplets of water on the grass. She was confused because she did not see rain the day before. Which one of the following statements explains Thabi's findings?

- A. At night, the water vapour in the air touching the grass cools down and forms droplets of water.
- B. Thabi was asleep when the rain fell.
- C. Grass gives off water at night.
- D. This is part of the water cycle.

66. In 1998, lightning in Congo killed a whole soccer team. Which of the following, would you not do if it was raining?

- A. close you windows if you were in a car
- B. use electricity at home
- C. stay away from windows and open doorways
- D. go for a swim in your pool

67. Which of the items shown below, A, B, C, or D will immediately change electrical energy to heat energy?

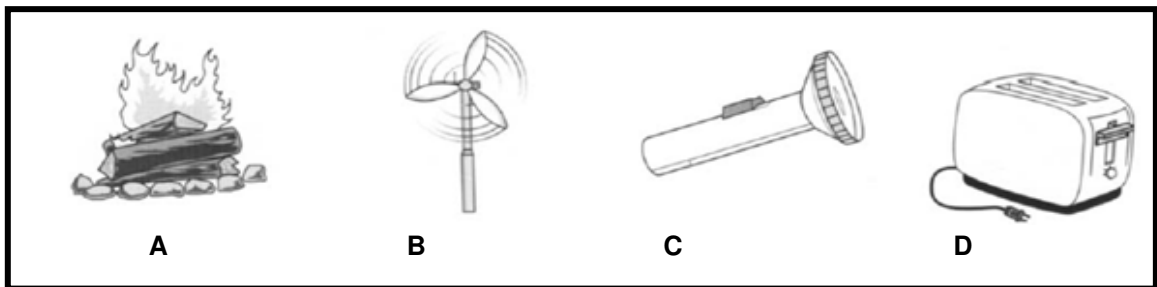

- A.
- B.
- C.
- D.

68. Diagrams below, A, B, C and D show the same tree during each of the four seasons. What is the order of the seasons according to the diagrams?

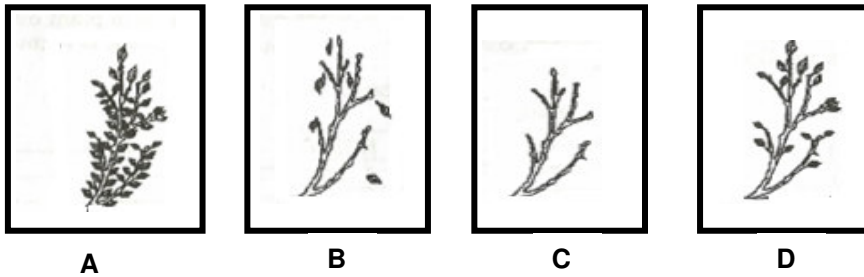

- A. spring, summer, autumn, winter
B. summer, autumn, winter, spring
C. winter, autumn, summer, spring
D. autumn, winter, spring, summer

69. The diagram below shows an electrical circuit.

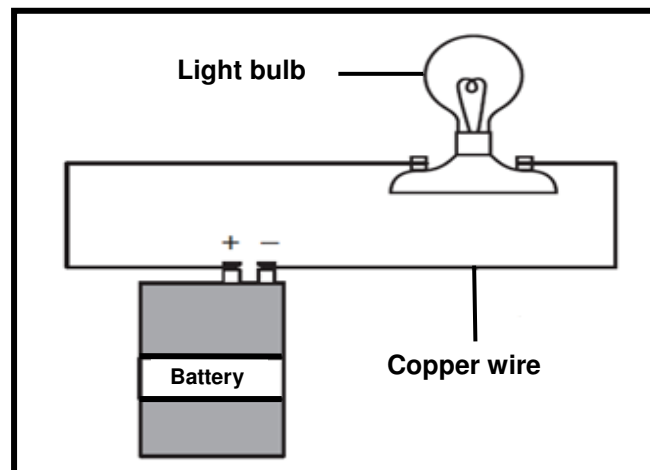

The purpose of the copper wire is to

- A. conduct electricity
B. produce electricity
C. store electricity
D. stop the flow of electricity

70. The table below shows the height of a bean plant over a three month period. The height of the plant was measured and recorded as shown in the table below.

Height of a bean plant	
Month	Height
March	4cm
April	9cm
May	14cm

If the pattern shown continues, the height of the plant in June will be..

- A. 23cm.
- B. 12cm.
- C. 19cm.
- D. 14cm.